

Surface water source heat pumps: Code of Practice for the UK

GSHPA Conference
Coventry
10th September 2015

Nic Wincott

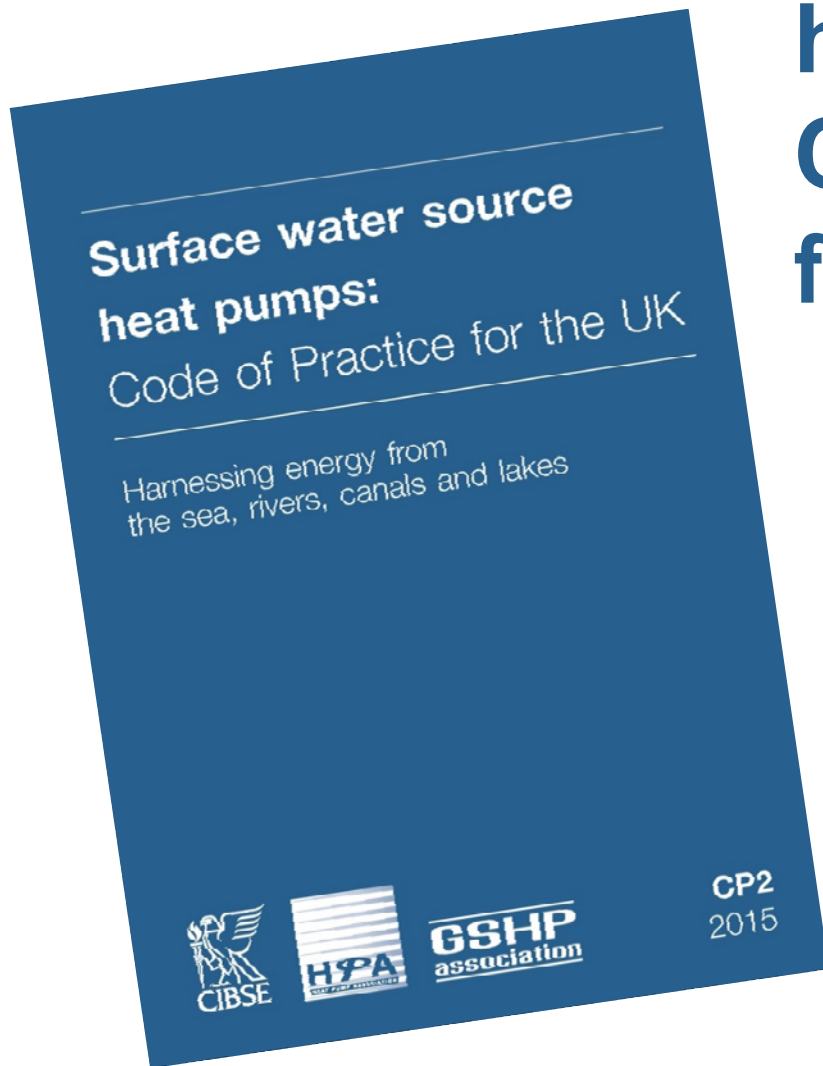

CP1

Companion to Heat Networks Code of Practice

CP2

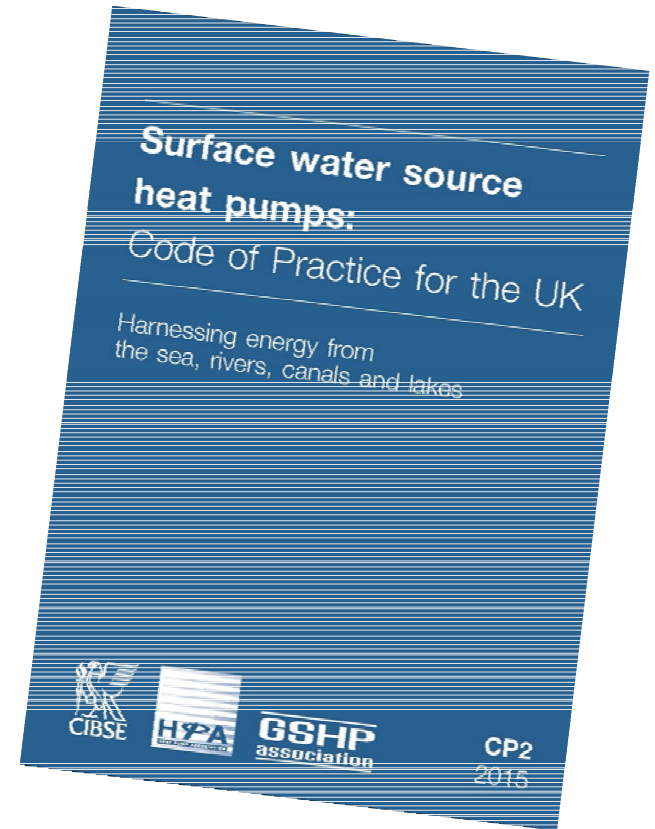

<http://www.cibse.org/knowledge/cibse-other-publications/cp1-heat-networks-code-of-practice-for-the-uk-new>

www.cibse.org/CP2consultation

GSHP
association

HPA
HEAT PUMP ASSOCIATION

CIBSE

Collaborative Publication

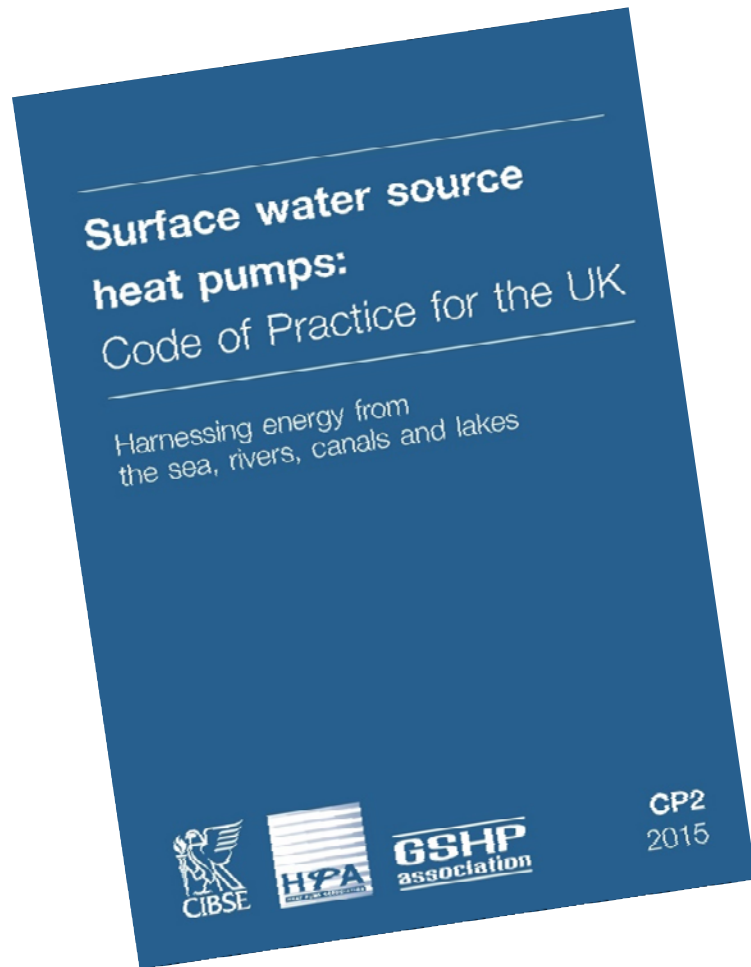

Consortium led by CIBSE in association with HPA & GSHPA supported by a 20 strong, diverse steering committee of industry experts.

With input from many more companies & individuals.



Supported by DECC...

SWSHPs can provide heat on a large scale, so DECC has produced a Surface Water Source Heat Map to identify the thermal potential of rivers, estuaries, canals and coastal waters in England.

The SWSHP Code of Practice is to complement the map by:

- Delivering energy efficiency and environmental benefits
- Preventing environmental harm
- Promoting effective long-lasting reliable installations.
- Improving the quality of feasibility studies, design, construction, commissioning and operation.



Department
of Energy &
Climate Change

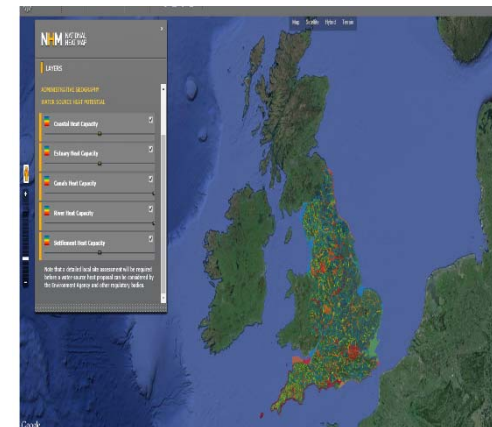

Environment Agency Input

The Environment Agency has been involved from the beginning.

- EA has changed a number of forms and systems and established a single point of entry for all enquiries
- EA has simplified the application process and are encouraging early engagement, long before the licence/permit application is to be made
- There are still concerns about their “bedside manner”



The Code of Practice

Surface Water only: Ground Water to follow?

What is a **Code of Practice** - a set of rules which describes how people working in a particular profession should behave.

Whereas a **Standard** exists principally to provide a reliable basis on which common expectations can be shared regarding specific characteristics of a product, service or process.

The Code of Practice is intended:

- For the whole supply chain
- To establish best practice where possible
- For use in tendering & contracts
- To underpin training & certification
- To take the technology to the next level

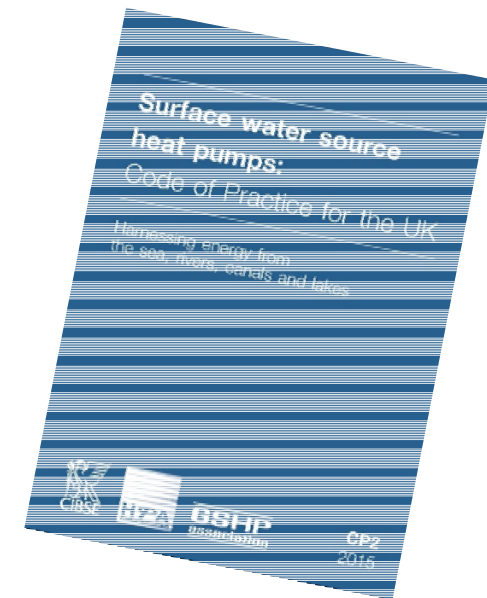

SWSHP Code of Practice

Other Considerations

The strategic aims for the deployment of SWSHP systems are:

- to reduce CO₂ and other greenhouse gas emissions
- to use natural resources sustainably and reduce or replace fossil fuel consumption
- to reduce overall cost of providing heating and/or cooling

SWSHPs can be used for heating, cooling - independently or simultaneously.

**This document leads with heating and is written from that perspective, but cooling is also discussed.

SWSHPs use either open or closed loops to collect heat from, or reject heat into surface water bodies.

**This document leads with open loop installations but also discusses closed loops

SWSHP Code of Practice

Why install a Surface Water Source Heat Pump?

Economic benefit

In most cases the key motivating factor will be financial:

- Government - grants and incentives
- SWSHP systems return an attractive ROI and mitigate against rising energy costs
- Increased CAPEX will be compensated by OPEX savings over the life of the building
- Other cost savings e.g. a gas supply and a flue may not be needed
- Maybe used for both heating and cooling – further improving efficiency and reducing cost.
- These balanced systems are compact and usually located in basement plantroom. The roof space released can be extremely valuable.

Environmental and reputational benefit

SWSHPs are a low carbon alternative to using fossil fuels.

Legislative requirements

To comply with national and international legislation: Climate Change Act 2008, Carbon Reduction Commitment (CRC), Energy Performance Building Directive (EPBD), Renewable Energy Sources Directive (RES), and Climate Change Levy (CCL), Building Regulations etc.

Some Applications

Challenges and Opportunities

Case Studies to show what diverse projects others have done to inspire innovative installations in the UK.

Figure 9: RNU case study (schematic)

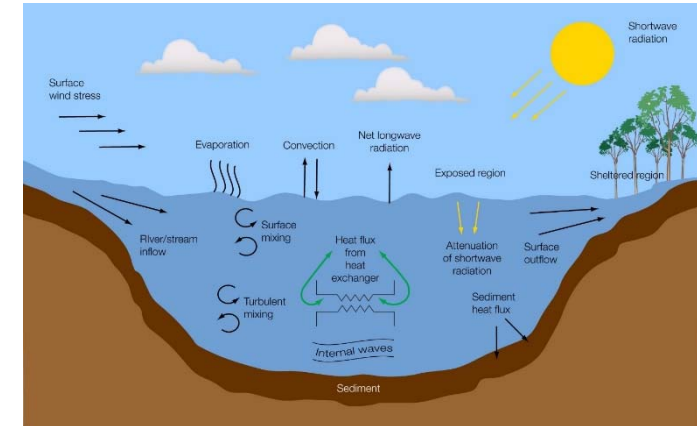
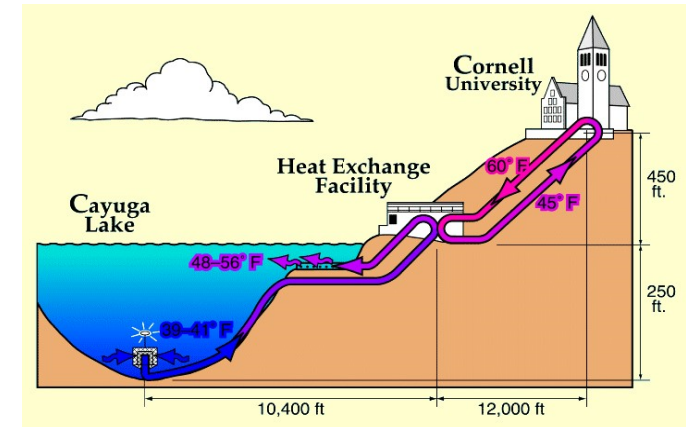
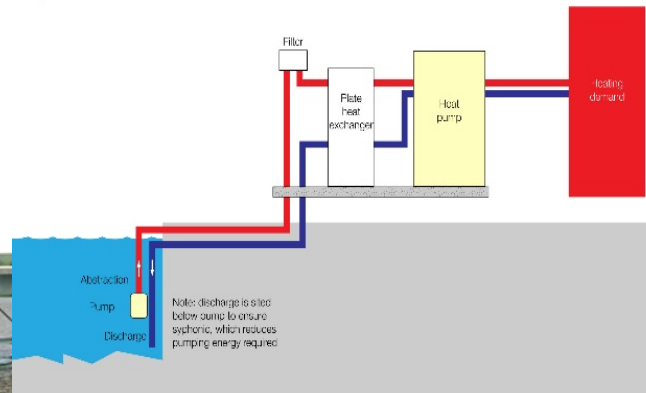

SWSHP Code of Practice

The Approach:

This Code of Practice sets out how a task should be undertaken and it is **not** intended to provide specific design guidance.

It is intended for larger projects, but smaller projects will also benefit.

It looks more daunting than it really is: many of the steps listed happen anyway, the idea is to ensure that they do happen how they should, when they should, so that the project is delivered on time, on budget and to a high standard.

Structure.

The Code of Practice is structured by:

- the typical sequence of a project by **stage**;
- for each project **stage** a number of **objectives** are set; and
- for each **objective** a number of **minimum requirements** are defined to achieve the objective.

SWSHP Plan of Work Goals

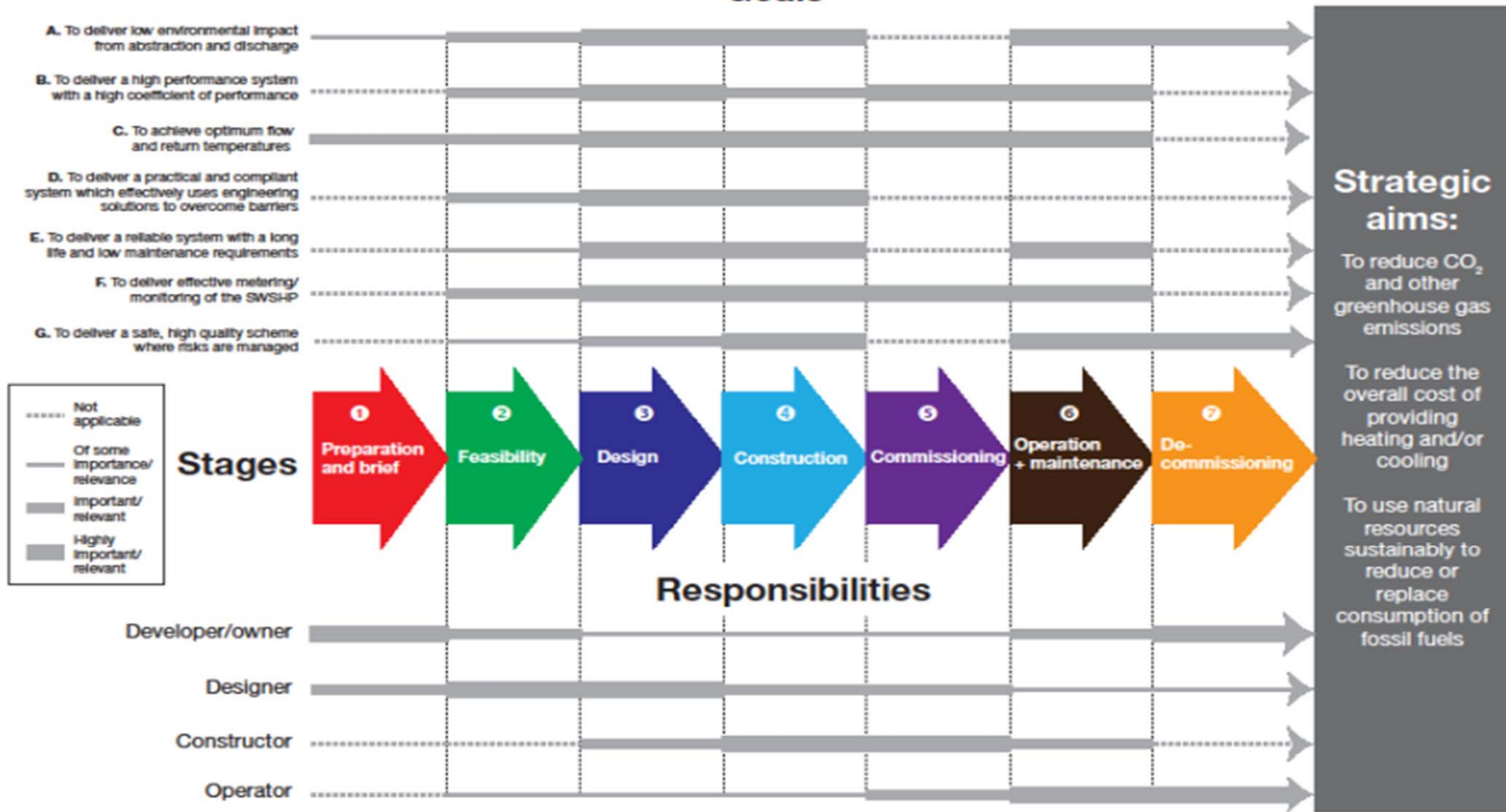

A more integrated supply chain

Where next?

Still under discussion and funding dependent

1. Feedback from using the Code – further revisions
2. A shorter summary – The essential do's and don'ts
3. Training – at all levels
4. Specialist technical seminars
5. Follow on: GWSHP Code of Practice.

Thank you

Nic Wincott

Lead Author
SWSHP Code of Practice

www.cibse.org/CP2consultation

